



## Effects of restraint on expansion due to delayed ettringite formation

Hassina Bouzabata <sup>a,b</sup>, Stéphane Multon <sup>a,\*</sup>, Alain Sellier <sup>a</sup>, Hacène Houari <sup>b</sup>

<sup>a</sup> Université de Toulouse; UPS, INSA; LMDC (Laboratoire Matériaux et Durabilité des Constructions); 135, avenue de Rangueil; F-31 077 Toulouse Cedex 04, France

<sup>b</sup> Laboratoire Matériaux et Durabilité des Constructions, Department of Civil Engineering, University of Constantine, Algeria

### ARTICLE INFO

#### Article history:

Received 23 September 2011

Accepted 3 April 2012

#### Keywords:

Delayed ettringite formation (C)

Mechanical properties (C)

Expansion (C)

Stress effect

### ABSTRACT

Delayed ettringite formation (DEF) is a chemical reaction that causes expansion in civil engineering structures. The safety level of such damaged structures has to be reassessed. To do this, the mechanical conditions acting on DEF expansions have to be analysed and, in particular, the variation of strength with expansion and the effect of restraint on the DEF expansion. This paper highlights several points: DEF expansion is isotropic in stress-free conditions, compressive stresses decrease DEF expansion in the direction subjected to restraint and lead to cracks parallel to the restraint, and expansion measured in the stress-free direction of restrained specimens is not modified. Thus restraint causes a decrease of the volumetric expansion and DEF expansion under restraint is anisotropic. Moreover, the paper examines the correlation between DEF expansion and concrete damage, providing data that can be used for the quantification of the effect of stresses on DEF induced expansion.

© 2012 Elsevier Ltd. All rights reserved.

### 1. Introduction

Alkali-silica reaction (ASR) and delayed ettringite formation (DEF) are endogenous chemical reactions that lead to concrete expansion of civil engineering structures [1–5]. The safety level of such damaged structures has to be evaluated with great care. Alkali-silica reaction has been largely studied and there are several methods for the reassessment of ASR-damaged structures [6–10]. Such methods are also necessary to reassess structures damaged by delayed ettringite formation or by a combination of the two reactions. The physical and chemical aspects of DEF expansions have already been well studied and discussed [4,11,12]. The mechanical conditions acting on DEF expansions also need to be studied. This includes the analysis and quantification of the mechanical effects of restraint on the development of DEF expansion.

Experiments have investigated the effect of stress on the anisotropy of ASR expansions [13–22]. ASR expansions were measured on specimens subjected to direct loading (with a creep device) [13–16] or to restraint (with steel reinforcement for example) [17–22]. In all the studies, expansion was decreased in the restrained or loaded direction [13–22]. For two studies, measurements showed that expansion was transferred to the less compressed direction [13,16] while another study did not show such transfer [15]. In the case of specimens restrained in the three directions (longitudinal loading and restraint in the other two directions), ASR expansions were not stopped but clearly reduced in the three directions, without significant modification of the imposed volumetric expansion [16].

Investigations on the effect of restraint on DEF expansion are also necessary. In this paper, three points of the mechanical behaviour of concrete undergoing DEF expansion are analysed: isotropy of stress-free expansion, anisotropy of expansion under restraint, and consequences of DEF expansion on compressive strength. After a presentation of the experimental conditions, the expansions measured on specimens under three mechanical conditions (stress-free and under two restraints) and the evolution of the compressive strength are reported. The measurements are then investigated with a mechanical analysis to discuss the consequences of the stress conditions on the development of DEF expansion. Finally, a relationship between the concrete damage (assessed by the evolution of the compressive strength) and the DEF expansions is proposed.

### 2. Experimental conditions

#### 2.1. Materials

Experiments were performed on mortar prisms (40 × 40 × 160 mm). The mortar used in this study had already been used in previous experiments on DEF [23–25]. The water/cement ratio was 0.55 and the sand/cement ratio was 3. The chemical composition of the Portland cement used is given in Table 1. As in the previous experiments, 3.1% of Na<sub>2</sub>SO<sub>4</sub> was added to the mixing water [23–25]. Siliceous sand known to be non-alkali-reactive was used (Table 1).

#### 2.2. Curing temperature

After casting, some of the specimens were cured at high temperatures with the heat treatment used in previous studies [23–25]: 1 h at

\* Corresponding author. Tel.: +33 5 61 55 67 05.

E-mail address: [multon@insa-toulouse.fr](mailto:multon@insa-toulouse.fr) (S. Multon).

**Table 1**  
Chemical compositions of cement and aggregate (%).

|           | SiO <sub>2</sub> | Al <sub>2</sub> O <sub>3</sub> | Fe <sub>2</sub> O <sub>3</sub> | CaO  | MgO  | SO <sub>3</sub> | K <sub>2</sub> O | Na <sub>2</sub> O | Na <sub>2</sub> Oeq | LOi |
|-----------|------------------|--------------------------------|--------------------------------|------|------|-----------------|------------------|-------------------|---------------------|-----|
| Cement    | 19.3             | 4.6                            | 2.2                            | 63.9 | 2.4  | 3.3             | 1.1              | 0.3               | 1.02                | –   |
| Aggregate | 96.1             | –                              | 0.4                            | 1.38 | 0.24 | –               | 0.72             | 0.79              | 1.26                | 0.4 |

20 °C, an increase from 20 to 80 °C in 4 h, a constant temperature of 80 °C for 10 h then a cooling to 20 °C in 10 h. The specimens were steamed in metal moulds, wrapped in watertight plastic film and covered by a metal plate to prevent evaporation of water during the heat treatment. At the same time, other specimens made in the same batch were stored at 20 °C. After cooling and demoulding, specimens were kept at 20 °C in endogenous conditions (sealed in plastic bags) for 28 days.

**2.3. Restraint and storage**

After the 28 days of curing, the specimens were put under restraint (Fig. 1). The device was composed of two stainless steel plates connected by four threaded stainless steel bars. The compressive force was transmitted through two stainless steel balls and two other steel plates were placed between the balls and the specimens in order to obtain uniform compressive stresses in the specimen (Fig. 1). Threaded bars of diameters 2 and 5 mm (restraints 4D2 and 4D5 respectively) were used to obtain two restraint levels. Slight stresses were applied at 28 days. The mean negative elastic strains measured in the longitudinal directions when restraints were applied were respectively 30 and 70 μm/m for the specimens under the restraints of 4D2 and 4D5. Once expansion occurred, the threaded bars restrained DEF expansion, which caused the longitudinal compressive stress to increase. After stabilisation of the expansions (at about 442 days), the restraints were withdrawn. The mean positive

elastic strains measured in the longitudinal directions when the restraints were withdrawn were respectively 80 and 160 μm/m for the specimens under the restraints of 4D2 and 4D5. In order to accelerate DEF development, the specimen and the whole experimental set-up were immersed in water at 38 °C [24].

**2.4. Measurement**

Before each measurement, the specimens were cooled from 38 °C to 20 °C. At the same time, mass measurements were performed on the specimens. The longitudinal displacements were measured with an extensometer (Fig. 3a - measurement length: 100 mm) between two stainless steel studs stuck on the specimen (Fig. 2). The transversal displacements were measured using an external ball-micrometer (Fig. 3b) pointing on two stainless steel studs stuck on the sides of the specimens (measurement length: 40 mm). For each specimen, two longitudinal measurements were made on two opposite faces (Fig. 2) and four transversal measurements (two for each direction - Fig. 2). In order to decrease scatter due to mortar fabrication, heat treatment and storage, only one batch was used to cast all the specimens for the study, all the specimens were cured during the same heat treatment and kept in the same volume of water.

**3. Experimental results**

**3.1. Stress-free expansion**

Strains of specimens kept immersed in water after 28 days in stress-free conditions have been plotted in Fig. 4. The specimens that had been subjected to the heat treatment during the curing period showed large expansions of between 1.3 and 2.2% due to DEF [23–25]. All the specimens in stress-free conditions exhibited map-cracking. The first significant cracks appeared for a strain of about 0.5% (after 80 days of immersion in water). Fig. 4 shows the strains

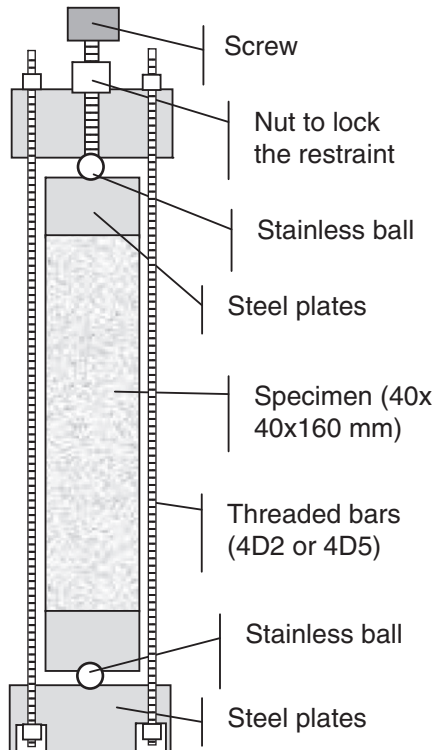

**Fig. 1.** Specimen under restraint.

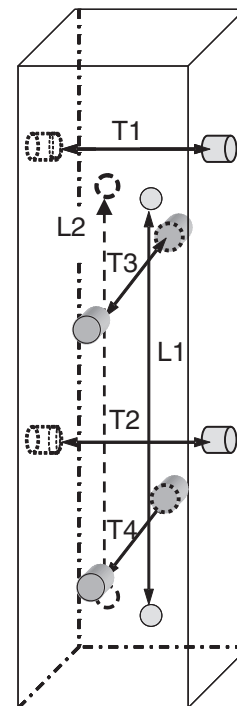

**Fig. 2.** Specimen with the steel studs used for the displacement measurements in the longitudinal (L1, L2) and in the transversal (T1 to T4) directions.

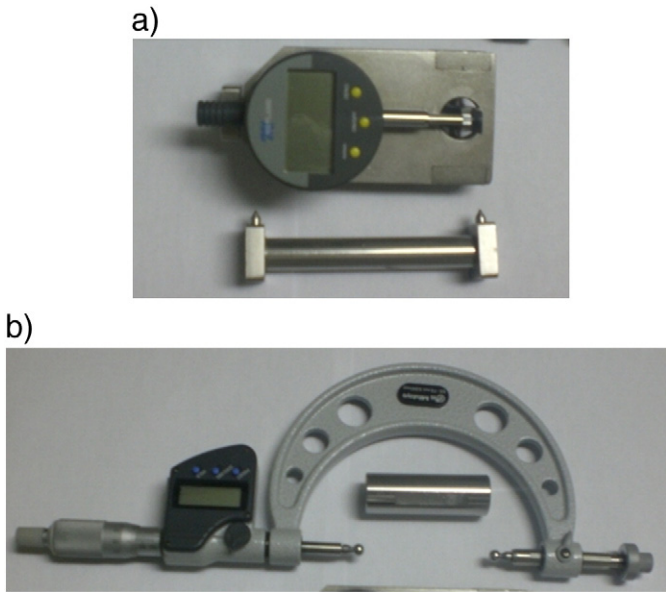

Fig. 3. Extensometers for the longitudinal (a) and the transversal (b) measurements.

measured on specimens obtained from several batches of the same mixture. The expansion kinetics were similar for all the specimens (with expansion beginning after about 60 days of immersion) but the range of final expansions was rather large (between 1.3 and 2.2%). This illustrates the discrepancy of DEF expansions, which could be quantified by a coefficient of variation of about 20% in this study, slightly lower than the coefficients of variation obtained for alkali-silica reaction expansions [22,26].

Strains were measured in the three directions of specimens obtained from the same batch (2 measurements in the longitudinal direction and 4 in the two transverse directions of each specimen – Fig. 2). The longitudinal and transverse expansions showed a smaller scatter (coefficient of variation lower than 10% – Fig. 5) than the longitudinal expansions obtained on specimens from different batches. Longitudinal and transverse strains were equal during the whole experiment; expansion caused by the delayed ettringite formation was thus isotropic in stress-free conditions.

### 3.2. Expansion under restraint

The longitudinal and transverse strains of specimens under restraint are compared with strains obtained on the stress-free specimens in

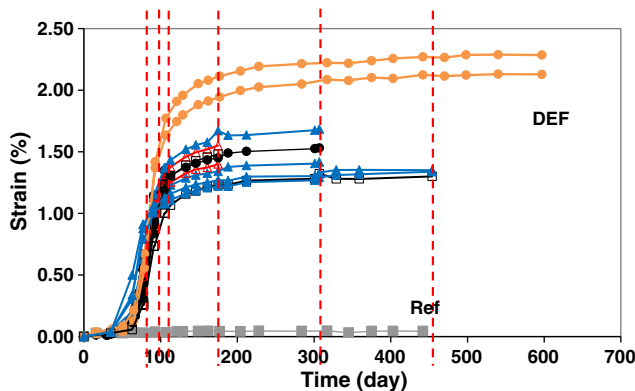

Fig. 4. Strain of specimens in stress-free conditions (each line corresponds to one specimen, specimens of a same batch are plotted with the same marker – dotted lines show the times of the mechanical tests).

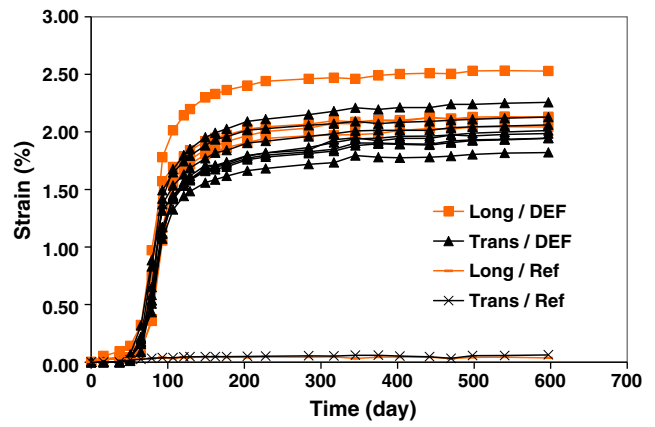

Fig. 5. Longitudinal and transversal strains of specimens in stress-free conditions.

Fig. 6. All the specimens exhibit cracks. Cracking was mainly longitudinal for the restrained specimens (parallel to the restraint). Cracks seemed to be wider for the specimens in stress-free conditions than for restrained specimens. The longitudinal expansions show the large effect of the restraint on the strains measured in the direction of compressive stress: final longitudinal expansions were only 0.6% and 0.2% for the specimens restrained by steel bars of 2 and 5 mm in diameter, respectively, and 2.1% for the specimens in stress-free conditions (Fig. 6 – decrease of about 75 and 90%). It is interesting to note that, although the relative decreases were considerable, the expansions stayed

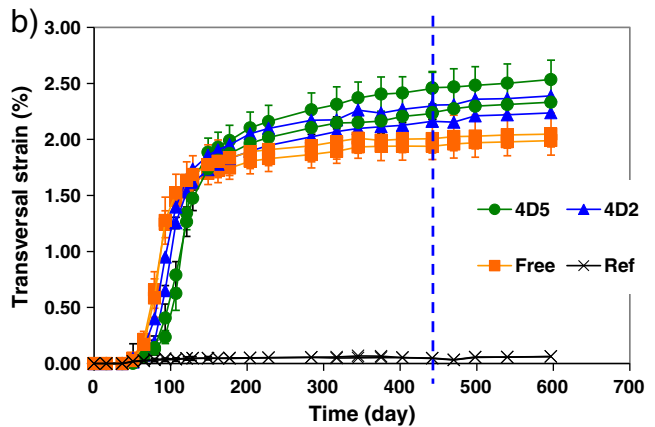
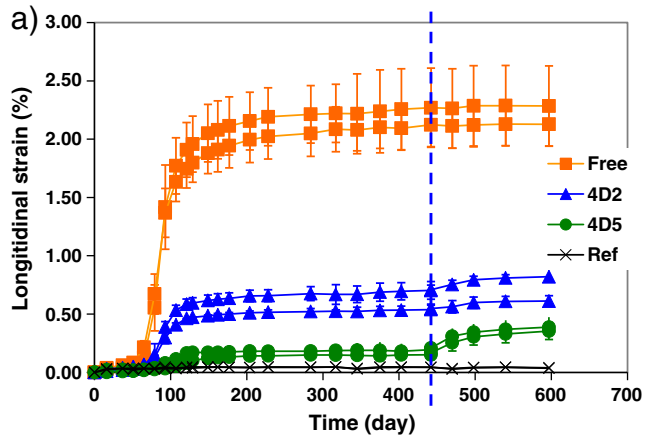

Fig. 6. Longitudinal (a) and transversal strains (b) of specimens subjected to DEF in stress-free conditions and under restraint (4D2 and 4D5 for the restraint by four bars of 2 and 5 mm respectively – the dotted line shows the time when restraint was withdrawn).

quite large in the restrained direction (for the strongest restraint, the expansion was still about 0.2%). DEF-induced transverse expansion showed (Fig. 6-b):

- a slight delay (between 10 and 20 days) in presence of the restraint,
- faster stabilisation for the specimens in stress-free conditions (after about 250 days of immersion),
- transversal expansions were slightly larger for the restrained specimens at 400 days (before the restraint was withdrawn), with strains of about 2.2 and 2.3% versus 2% for stress-free specimens.

Finally, the longitudinal restraint had a smaller effect on transverse strains than on longitudinal strains. Moreover, all the transverse strains were measured in the two transverse directions of the specimens. Little scatter was observed according to the direction. Expansions in the two stress-free transverse directions were similar.

After the restraints had been withdrawn (442 days), the longitudinal expansions showed slight increases, particularly for the most restrained specimens (Fig. 6). They stabilised quickly (at 540 days) and did not significantly modify the results (Fig. 6-a). As specimens were under compressive stresses due to restrained expansion and as DEF expansion appeared to be stabilised in other specimens, the expansion increase may have been due to creep recovery. No significant modifications were measured for transverse expansion (Fig. 6-b).

### 3.3. Compressive strength

Compressive strength was measured on prismatic specimens (40×40×40 mm) at time-steps chosen according to the expansions measured on the specimens (Fig. 4). The evolution of the compressive strength of the reference mortar and of the mortar damaged by delayed ettringite formation have been plotted in Fig. 7. The reference specimens showed the usual increase of compressive strength with time due to continuous cement hydration. The specimens that had been subjected to the heat treatment showed a decrease in strength (about 40%). 28 days after casting, the compressive strength was equal to 46.5 MPa. A large strength decrease occurred mainly between 70 and 100 days, corresponding to the significant increase of expansion (Fig. 4-b), and the compressive strength reached a minimum value of 25 MPa at 180 days. After 180 days, while expansion was stabilised, a slight increase could be noted (the same increase as for the compressive strength measured on the reference specimens). The evolution of relative compressive strength has been plotted versus expansion in Fig. 8. The maximal decrease (about 40%) was reached for expansion of

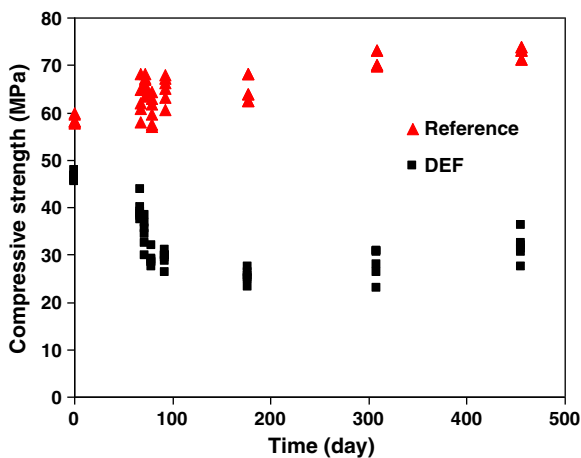

Fig. 7. Evolution of the compressive strength.

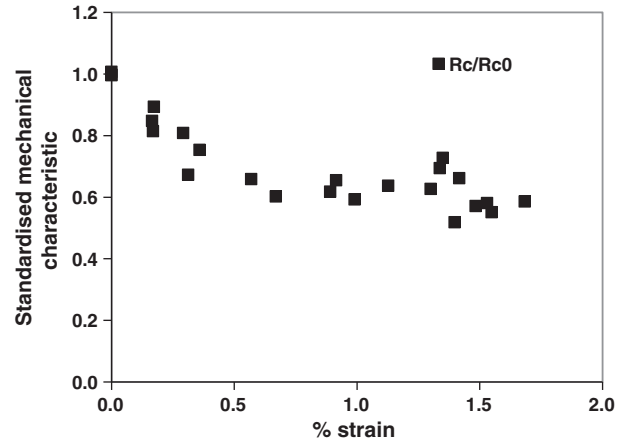

Fig. 8. Decrease of compressive strength according to DEF expansion.

about 0.7%. For expansions higher than 0.7%, the reduction of the compressive strength appears to be stable.

## 4. Analysis and discussion

### 4.1. Chemo-mechanical calculations

The aim of this part is to analyse the strains of the restrained specimen by means of chemo-mechanical calculations, as can be done in the calculation of ASR-damaged structures [6,7]. The calculations are based on the assumption that DEF expansion can be considered as imposed strain, as proposed in [27]. During the measurements, DEF expansion was isotropic in stress-free conditions. For the specimens subjected to restraint, the strains were the same in the two transversal directions but largely reduced in the longitudinal, restrained direction. This anisotropy can have two causes: the only elastic effect of restraint and the reduction of DEF-induced expansion in the restraint direction. Elastic calculations performed with the assumption of isotropic chemically imposed strain show that the reductions of the measured strains due to the elastic effect are respectively about 10% and 40% under the restraints of 4D2 and 4D5. The reductions are thus lower than the reduction of respectively 75% and 90% observed in the experimental results. This observation has already been made for ASR expansion under restraint [28] and leads to assume that the chemically imposed strains are not isotropic. ASR modelling based on the assumption that ASR expansion can be considered as chemically imposed strains usually used an anisotropic coefficient to modify the imposed strains according to the anisotropy of loading [29,30]. As the restraint was uniaxial, the chemically imposed strains were assumed to be orthotropic to take account of the effect of restraint on the expansion in each direction. They can be written:

$$\underline{\underline{\varepsilon}}_{imp} = \begin{pmatrix} \varepsilon_{imp}^T & 0 & 0 \\ 0 & \varepsilon_{imp}^T & 0 \\ 0 & 0 & \varepsilon_{imp}^L \end{pmatrix} \quad (1)$$

As for the alkali-silica reaction [6,7], the constitutive law of concrete damaged by DEF is:

$$\underline{\underline{\sigma}} = \left( K_c - \frac{2}{3} G_c \right) tr(\underline{\underline{\varepsilon}} - \underline{\underline{\varepsilon}}^p) I + 2G_c (\underline{\underline{\varepsilon}} - \underline{\underline{\varepsilon}}^p) - 3K_c \underline{\underline{\varepsilon}}_{imp} \quad (2)$$

with:  $\underline{\underline{\varepsilon}}^p$  the plastic strains matrix.

In this work, the mean structural compressive stresses are lower than 5 MPa and thus lower than the mean compressive strength; the plastic strains  $\underline{\underline{\varepsilon}}^p$  are then equal to zero. The Eq. (2) becomes:

$$\underline{\underline{\sigma}} = \left( K_c - \frac{2}{3} G_c \right) \text{tr} \underline{\underline{\varepsilon}} I + 2 G_c \underline{\underline{\varepsilon}} - 3 K_c \underline{\underline{\varepsilon}}_{imp} \quad (3)$$

with:

$$K_c = \frac{E_c}{3(1-2\nu_c)} \quad (4)$$

and

$$G_c = \frac{E_c}{2(1+\nu_c)} \quad (5)$$

where  $E_c$  and  $\nu_c$  are respectively the Young's modulus of the concrete and its Poisson's coefficient, assumed isotropic.  $\underline{\underline{\varepsilon}}$  is known from the transverse and longitudinal measurements:

$$\underline{\underline{\varepsilon}} = \begin{pmatrix} \varepsilon_{meas}^T & 0 & 0 \\ 0 & \varepsilon_{meas}^T & 0 \\ 0 & 0 & \varepsilon_{meas}^L \end{pmatrix} \quad (6)$$

Boundary conditions are given by the two following equations:

- The longitudinal stresses in concrete are equal to the restraint stress:

$$\sigma_{zz}^c(z) = \sigma_{rest} \quad (7)$$

with  $\sigma_{rest}$  the stress due to the threaded bar restraint.

- There are no transverse stresses:

$$\sigma_{xx}^c(z) = \sigma_{yy}^c(z) = 0 \quad (8)$$

Therefore, the chemically imposed strains can be identified from the strains measured on specimens:

$$\varepsilon_{imp}^T = \frac{1}{3K_c} \left[ \left( 2K_c + \frac{2}{3}G_c \right) \varepsilon_{meas}^T + \left( K_c - \frac{2}{3}G_c \right) \varepsilon_{meas}^L \right] \quad (9)$$

$$\varepsilon_{imp}^L = \frac{1}{3} \left[ \left( 2 - \frac{4G_c}{3K_c} \right) \varepsilon_{meas}^T + \left( 1 + \frac{4G_c}{3K_c} \right) \varepsilon_{meas}^L - \frac{\sigma_{rest}}{K_c} \right] \quad (10)$$

It can be noted that the term  $\sigma_{rest}/K_c$  is negligible compared to the other two terms of the equation (about 0.05% compared to more than 1%) in this work.

The volumetric chemically imposed strain is defined by:

$$\frac{\Delta V}{V} = \varepsilon_{imp}^L + 2\varepsilon_{imp}^T \quad (11)$$

By combining Eqs. (9), (10) and (11), the following equation can be obtained:

$$\frac{\Delta V}{V} = \varepsilon_{imp}^L + 2\varepsilon_{imp}^T = \varepsilon_{meas}^L + 2\varepsilon_{meas}^T - \frac{\sigma_{rest}}{3K_c} \quad (12)$$

The Young's modulus of the concrete was equal to 31,000 MPa when restraint was imposed (28 days after casting). The Poisson's coefficient was taken equal to 0.2. In this study, the last term of Eq. (12) (about 0.001%) is negligible compared to the measured strains (about 1%). In this case, it can be noted that the imposed volumetric strain is equal to the measured volumetric strain.

## 4.2. Analysis

### 4.2.1. Induced stresses

The stresses in the specimens could be assessed from the longitudinal strains measured at the beginning of the test and when the restraints were withdrawn. When restraints were applied, the mean negative strains in the longitudinal directions were 30 and 70  $\mu\text{m}/\text{m}$  for the specimens under the restraint of 4D2 and 4D5 respectively. Before DEF occurred, the Young's modulus of the mortar had been measured. It was about 31,000 MPa. Mean compressive stresses could thus be assessed: about 0.9 and 2 MPa for the restraints 4D2 and 4D5, respectively, at the beginning of the tests.

Once expansion occurred, DEF expansions were restrained by the threaded bars, which implied an increase of the longitudinal compressive stresses. The final stresses could be assessed from the elastic strains measured in the longitudinal directions when the restraints were withdrawn. Strains were 80 and 160  $\mu\text{m}/\text{m}$  for the specimens under the restraints of 4D2 and 4D5 respectively. For DEF, as for ASR, mechanical characteristics such as compressive strengths and Young's modulus are modified by cracking induced by expansion. Young's modulus decreases as the cracking develops. The effect of restraint on DEF or ASR expansions leads to cracking, mainly parallel to the restraint direction as was observed on the specimens studied in this work. Therefore, it leads to anisotropic damage and the decrease of the Young's modulus is lower along the restraint directions than in stress-free directions [31]. In order to quantify the compressive stresses at the end of the tests, the decrease in Young's modulus was assumed to be proportional to the decrease in compressive strength for an expansion equal to the strain measured in the restraint direction (Fig. 8). The mean strains measured in the longitudinal direction were 0.6 and 0.2% for the restraints 4D2 and 4D5 respectively. For such expansions, the decreases of the compressive strength were about 65% and 85% (Fig. 8). For an initial value of 31,000 MPa, this led to Young's moduli of about 20,150 and 26,350 MPa and thus to final compressive stresses of about 1.6 and 4.2 MPa. Therefore, compressive stresses increased from 0.9 to 1.6 MPa for restraint 4D2 and from 2 to 4.2 MPa for 4D5.

### 4.2.2. Calculated strains

The chemically imposed strains according to the chemo-mechanical calculations performed just above (Eqs. 9 and 10) have been plotted in Fig. 9 for the stress-free and restrained specimens. The imposed longitudinal strains were greatly influenced by the restraint, with decreases of respectively 45 and 55% for the restraints 4D2 and 4D5 in comparison with the stress-free specimens (Fig. 9-a). These reductions are smaller than those calculated for the measured strains (75 and 90%). It is due to the elastic effect of the restraint. The imposed longitudinal strains obtained for the two restraints (1.15 and 0.90% before the restraints were withdrawn) are closer than the measured longitudinal strains (0.60 and 0.20% at the same time – thus a factor of 3 between the measurements and only 1.25 between the imposed strains). The restraints seemed to have little effect on the imposed transverse strains, with a slight delay as for the measured strains, but with no differences of final strains (Fig. 9-b). Volumetric strains (Eq. (12)) have been plotted in Fig. 10. The volumetric strains of the restrained specimens were similar (volumetric strains of about 5%) and showed a reduction of about 20% compared to the volumetric strain of the stress-free specimens (6.1% - Fig. 10).

The effect of restraint on expansion can be quantified by the anisotropy coefficient of DEF-induced expansions (ratio of the longitudinal strain to the transverse strain). The assessment of the anisotropy coefficients for the stress-free and restrained specimens are presented in Fig. 11. The longitudinal and transversal strains were highly correlated, with a correlation coefficient very close to 1 for the three stress conditions. As observed in the presentation of the experimental results, DEF expansions were isotropic in stress-free conditions. The anisotropy coefficient was about 1.05 (Fig. 11). The anisotropy of stress-free expansions due to

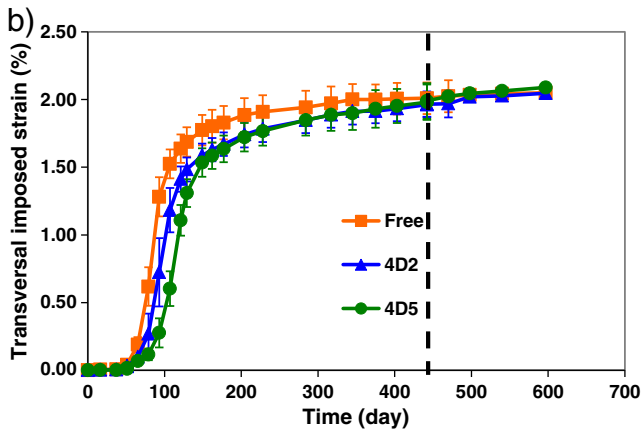
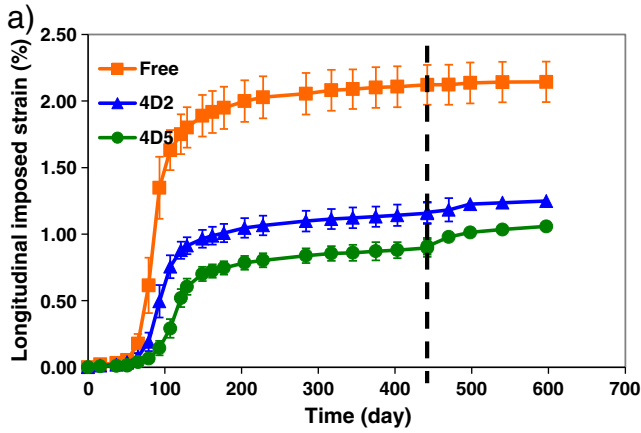

Fig. 9. Imposed longitudinal (a) and transversal (b) strains.

DEF was not so large as for ASR expansions, which usually present an anisotropy coefficient of about 2 in stress-free conditions [22,26,32]. For ASR, the largest expansion was measured in the direction parallel to casting [22,26]. For DEF, the casting direction did not appear to modify expansion. The anisotropy coefficients were 0.6 and 0.45 for restraints 4D2 and 4D5 respectively (Fig. 11). The decrease of the anisotropy coefficients quantifies the decrease of the strains in the restraint direction while strains in the stress-free directions are not modified.

Fig. 12 shows the variations of the volumetric strains and of the anisotropy coefficient with the final compressive stress. It illustrates the decrease of the volumetric strains by the compressive stresses induced by the restraints (decrease of 20% between the stress-free and the restrained specimens) and the small effect of the increase in the

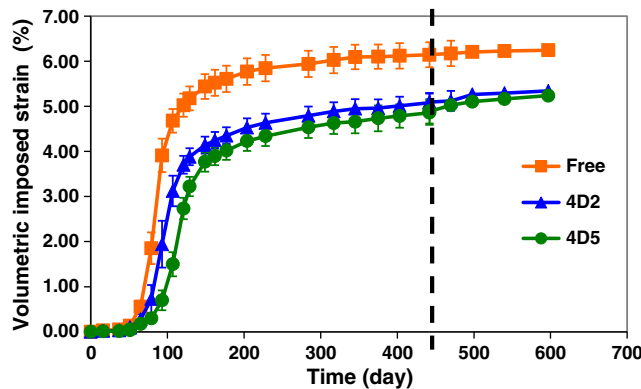

Fig. 10. Volumetric strains for stress-free and restrained specimens.

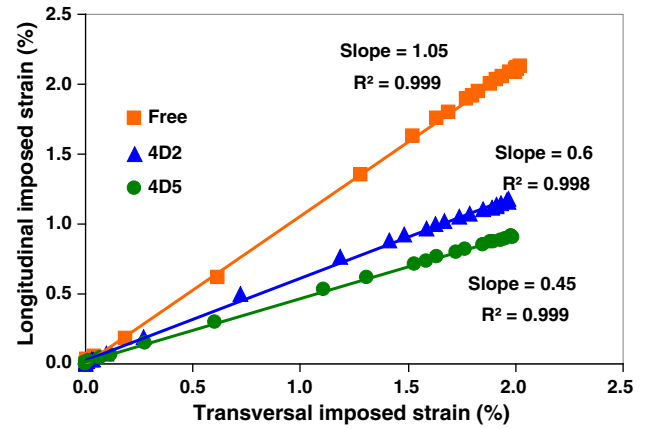

Fig. 11. Anisotropy coefficients of DEF expansions under restraint.

restraint on the volumetric strain (decrease of 5% between the two restraints). The effect of the anisotropy seems to be greater, with reductions of 45 and 55% of the anisotropy coefficient for the restrained specimens compared to stress-free specimens. Moreover, the decrease was still large with the increase of the restraint: a reduction of 25% of the anisotropy coefficient was obtained between the two restraints.

The limit of this chemo-elastic approach is the representativeness of the chemically imposed strains. The chemically imposed expansion included the delayed ettringite formation, which was the real cause of expansion, and the induced cracking, which was the result of the delayed ettringite formation. Moreover, such elastic calculations do not allow a determination of anisotropic damage, which is observed on DEF-damaged structures and restrained specimens. However, the interest of such a chemo-elastic approach is its simplicity of use for experimental interpretation.

#### 4.2.3. Damage and expansion

The decrease in the compressive strength according to expansion obtained in this work (Fig. 8) and results obtained by Brunetaud [33] have been plotted in Fig. 13. For expansions lower than 1%, the experimental results are quite close. For expansions larger than 1%, Brunetaud's work shows a continuous decrease (Fig. 13) while the compressive strength appears to be stabilised in the present study. The differences between the two studies can be explained by the different experimental conditions (types of aggregate, specimen sizes, mix-design...). Moreover, at 1% expansion, the results of mechanical tests can be influenced by the significant damage; for such expansion,

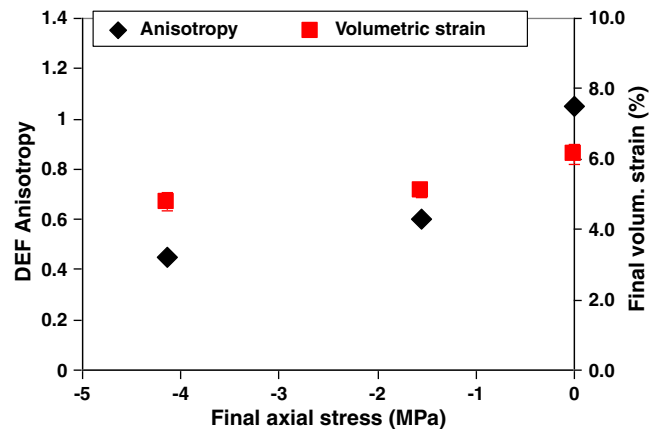

Fig. 12. Anisotropy coefficient of DEF expansions and volumetric strain according to the final axial stress.

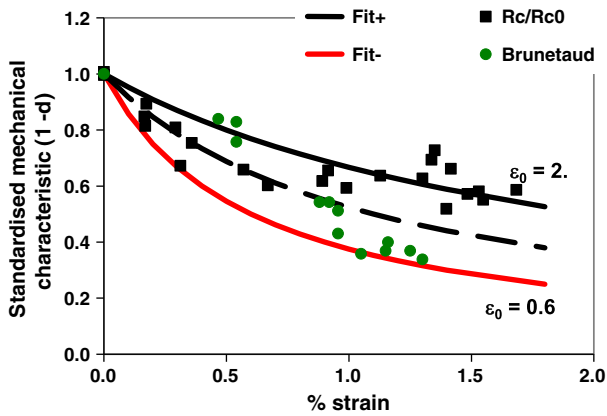

Fig. 13. Standardised mechanical characteristic (compared with Brunetaud's work [33] and modelled by Capra and Sellier's law [34]).

the discrepancy for experimental results can be large and comparisons are then difficult.

Modelling use a relationship between expansion and decrease in mechanical characteristics to assess the damage due to expansive reactions [9,31,34]. The damage  $d$  can be calculated from the decrease in the compressive strength:

$$d(t) = 1 - \frac{f_c(t)}{f_c(t_0)} \quad (13)$$

where  $f_c(t)$  the compressive strength at time  $t$  and  $f_c(t_0)$  the initial compressive strength.

As a first approach, this relationship is assumed to be similar to the relationship used for the alkali-silica reaction. If the curve fitting of this relationship is difficult, another law should be proposed. For ASR-modelling, Capra and Sellier proposed the following relationship between expansion and damage:

$$\varepsilon = \varepsilon_0 \frac{d}{1-d} \quad (14)$$

with  $\varepsilon$  the expansion measured on specimens with damage  $d$  and  $\varepsilon_0$  a parameter obtained by curve fitting. Note that, even though Eq. (14) remains scalar,  $d$  can be the main value of an anisotropic damage tensor, and so the chemically imposed expansion becomes different in each loading direction, depending on the stress state which acts on the damage tensor components [34].

The proposed relationship can be fitted on the experimental results and thus gives an acceptable representation of the increase of damage with expansion. The effect of expansion on the mechanical characteristics of damaged concrete is difficult to generalise. For ASR, some authors have reported large decreases in mechanical strength [35–37] whereas other experimental works show smaller decreases that mainly concern the Young's modulus while compressive strength is not modified [22,38,39]. For ASR expansion, Capra and Sellier obtained a value of  $\varepsilon_0$  lying between 0.3 and 0.6% [34]. The fitting leading to the value of 0.3% was based on a tensile strength test performed by ISE [35] while the compressive strength led to 0.6%. Capra and Sellier kept 0.3% for the sake of safety as a small value of  $\varepsilon_0$  leads to an overestimate of the damage for a given expansion. The results of measurements obtained for the effect of DEF expansions on the compressive strength are included between two curves with  $\varepsilon_0$  between 0.6 and 2%. Prudence requires the lowest (0.6%) to be taken for the effect of DEF expansion on compressive characteristics. It means that DEF expansion leads to damage of mechanical properties in compression that are in the same range as ASR expansion. The relationship between damage and DEF expansion (Eq. (14)) appears to be similar to the relationship used in the

mechanical models employed for the assessment of ASR-damaged structures [9,31,34] which could then be kept for the assessment of DEF-damaged structures.

## 5. Conclusion

The aim of this paper has been to study the mechanical consequences of DEF expansion. Two aspects were analysed in particular: the effect of restraint on the DEF expansion and the evolution of compressive strength with expansion. Several points have been made:

- DEF expansion is isotropic in stress-free conditions,
- Compressive stresses decrease DEF expansion in the direction subjected to restraint and lead to cracks parallel to the restraint. The larger the restraint, the smaller the DEF expansion. However, DEF expansion can be greater than 0.2% for stresses of about 4 MPa.
- Expansion measured in the stress-free direction of restrained specimens is not modified, and thus restraint causes a decrease in the volumetric expansion (decrease of 20% for the restrained specimens compared to stress-free ones).
- Therefore, expansion induced by DEF is anisotropic in restrained conditions. The differences of expansion between stress-free and restrained directions can be quantified by a coefficient of anisotropy of 0.6 and 0.45 for compressive stresses of 1.6 and 4.2 MPa respectively.
- The evolution of concrete damage with DEF expansion has been quantified.

Unlike the case for ASR, no transfer of expansion was noted on restrained specimens and the casting direction appeared not to modify DEF expansion. The differences between ASR and DEF could be explained by the difference of viscosity of the chemical products formed by the reactions. ASR products can migrate in the porosity and cracks after their formation, which allows the transfer of gel from the aggregate to the crack parallel to the unloaded directions and thus an increase of expansion in the free directions. DEF products are crystallized and, once formed, cannot move so easily in the cracks. Therefore, the place where reaction products are formed can have consequences on the damage process. Structural models have to take account of the effect of stresses on DEF expansion to perform relevant calculations to reassess DEF damaged structures and this particularity of DEF expansion should be considered. Works are in progress to link the volume of ettringite produced during the delayed formation with the induced expansions in restrained conditions and considering the concrete damage. Thus, the data provided in this experimental study will be used for the quantification of the effect of stresses on DEF induced expansion.

## References

- [1] P. Tepponen, B.E. Ericksson, Damages in concrete railway sleepers in Finland, *J. Nord. Concr. Res.* 6 (1987) 199–209.
- [2] C. Larive, N. Louarn, Diagnosis of alkali-aggregate reaction and sulphate reaction in French structures, Proceedings of the 9th International Conference on Alkali Aggregate Reaction, Concrete Society Publication CS 106, London, Great-Britain, 1992, pp. 587–598.
- [3] A. Shayan, G.W. Quick, Microscopic features of cracked and uncracked concrete railway sleepers, *ACI Mat. J.* 89 (1992) 348–361.
- [4] S. Diamond, Delayed ettringite formation - process and problems, *Cem. Conc. Comp.* 18 (1996) 205–215.
- [5] M. Thomas, K. Folliard, T. Drimalas, T. Ramlochan, Diagnosing delayed ettringite formation in concrete structures, *Cem. Concr. Res.* 38 (2008) 841–847.
- [6] F.-J. Ulm, O. Coussy, K. Li, C. Larive, Thermo-chemo-mechanics of ASR expansion in concrete structures, *J. Eng. Mech.* 126 (3) (2000) 233–242.
- [7] K. Li, O. Coussy, Concrete ASR degradation: from material modeling to structure assessment, *Concr. Sci. Eng.* 4 (2002) 35–46.
- [8] V. Saouma, L. Perotti, T. Shimpou, Stress Analysis of Concrete Structures Subjected to Alkali-Aggregate Reactions, *ACI Struct. J.* 104 (5) (2007) 532–541.
- [9] A. Sellier, E. Bourdarot, S. Multon, M. Cyr, E. Grimal, Combination of Structural monitoring and laboratory tests for the assessment of AAR-swelling - Application to a gate structure dam, *ACI Mat. J.* 106 (3) (2009) 281–290.
- [10] C. Comi, R. Fedele, U. Perego, A chemo-thermo-damage model for the analysis of concrete dams affected by alkali-silica reaction, *Mech. Mater.* 41 (2009) 210–230.
- [11] H.F.W. Taylor, C. Famy, K.L. Scrivener, Delayed ettringite formation, *Cem. Concr. Res.* 31 (2001) 683–693.

- [12] M. Collepardi, A state of the art review on delayed ettringite attack on concrete, *Cem. Conc. Comp.* 25 (2003) 401–407.
- [13] C. Larive, A. Laplaud, M. Joly, Behavior of AAR-affected concrete: Experimental data, Proceedings of the 10th International Conference on Alkali-Aggregate Reaction, Melbourne, Australia, 1996, pp. 670–677.
- [14] T. Ahmed, E. Burley, S. Rigden, The effect of alkali-silica reaction on the fatigue behaviour of ordinary concrete tested in compression, indirect tension and flexure, *Mag. Concr. Res.* 51 (6) (1999) 375–390.
- [15] C. Gravel, G. Ballivy, K. Khayat, M. Quirion, M. Lachemi, Expansion of AAR concrete under triaxial stress: simulation with instrumented concrete block, Proceedings of the 11th International Conference on Alkali-Aggregate Reaction, Québec, Canada, 2000, pp. 949–958.
- [16] S. Multon, F. Toutlemonde, Effect of applied stresses on alkali-silica reaction-induced expansion, *Cem. Con. Res.* 36 (2006) 912–920.
- [17] S. Inoue, M. Fujii, K. Kobayashi, K. Nakano, Structural behaviors of reinforced concrete beams affected by alkali-silica reaction, Proceedings of the 8th International Conference on Alkali-Aggregate Reaction, Kyoto, Japan, 1989, pp. 727–732.
- [18] R.N. Swamy, M.M. Al-Asali, Control of alkali-silica reaction in reinforced concrete beams, *ACI Mater. J.* 87 (1990) 38–46.
- [19] A.E. Jones, L.A. Clark, The effects of restraint on ASR expansion of reinforced concrete, *Mag. Concr. Res.* 48 (174) (1996) 1–13.
- [20] S. Fan, J.M. Hanson, Length expansion and cracking of plain and reinforced concrete prisms due to alkali-silica reaction, *ACI Struct. J.* 95 (4) (1998) 480–487.
- [21] T.U. Mohammed, H. Hamada, T. Yamaji, Alkali-silica reaction-induced strains over concrete surface and steel bars in concrete, *ACI Mater. J.* 100 (2003) 133–142.
- [22] S. Multon, J.-F. Seignol, F. Toutlemonde, Structural behavior of concrete beams affected by alkali-silica reaction, *ACI Mater. J.* 102 (2) (2005) 67–76.
- [23] G. Escadeillas, J.-E. Aubert, M. Segerer, W. Prince, Some factors affecting delayed ettringite formation in heat-cured mortars, *Cement Concr. Res.* 37 (2007) 1445–1452.
- [24] N. Leklou, Contribution à la connaissance de la réaction sulfatique interne, PhD thesis, Toulouse, Université de Toulouse, 2008 (in French).
- [25] N. Leklou, J.-E. Aubert, G. Escadeillas, Microscopic observations of samples affected by delayed ettringite formation (DEF), *Mater. Struct.* 42 (2009) 1369–1378.
- [26] C. Larive, M. Joly, O. Coussy, Heterogeneity and anisotropy in ASR affected concrete – consequences for structural assessment, Proceedings of the 11th International Conference on Alkali-Aggregate Reaction, Québec, Canada, 2000, pp. 969–978.
- [27] N. Baghdadi, J.-F. Seignol, F. Toutlemonde, Modélisation du couplage chimico-mécanique pour calculer une structure en béton atteinte de réaction sulfatique interne, 18ème Congrès Français de Mécanique, Grenoble, France, 2007.
- [28] S. Multon, J.-F. Seignol, F. Toutlemonde, Chemomechanical assessment of beams damaged by Alkali-Silica Reaction, *ASCE, J. Mater. Civ. Eng.* 18 (2006) 500–509.
- [29] V. Saouma, L. Perotti, Constitutive model for alkali-aggregate reactions, *ACI Mater. J.* 103 (3) (2006) 194–202.
- [30] N. Baghdadi, F. Toutlemonde, J.-F. Seignol, Modélisation de l'effet des contraintes sur l'anisotropie de l'expansion dans les bétons atteints de réactions de gonflement interne, XVèmes Rencontres de l'AUGC, Bordeaux, France, 2007.
- [31] E. Grimal, A. Sellier, Y. Le Pape, E. Bourdarot, Creep shrinkage and anisotropic damage in AAR swelling mechanism, part I: a constitutive model, *ACI Mater. J.* 105 (2008) 227–235.
- [32] N. Smaoui, M.A. Bérubé, B. Fournier, B. Bissonnette, Influence of specimen geometry, direction of casting, and mode of concrete consolidation on expansion due to ASR, *J. Cem. Concr. Agg. (ASTM)* 26 (2) (2004) 58–70.
- [33] X. Brunetaud, L. Divet, D. Damidot, Impact of unrestrained Delayed Ettringite Formation-induced expansion on concrete mechanical properties, *Cem. Conc. Res.* 38 (2008) 1343–1348.
- [34] B. Capra, A. Sellier, Orthotropic modelling of alkali-aggregate reaction in concrete structures: numerical simulations, *Mech. Mater.* 35 (2003) 817–830.
- [35] R. Pleau, M.A. Bérubé, M. Pigeon, B. Fournier, S. Raphael, Mechanical Behavior of Concrete Affected by ASR, Proceedings of the 8th International Conference on Alkali-Aggregate Reaction, Kyoto, Japan, 1989, pp. 721–726.
- [36] Institution of Structural Engineers, Structural effects of alkali-silica reaction, technical guidance on the appraisal of existing structures, Published by the Institution of Structural Engineers, London, 1992.
- [37] S. Fan, J.M. Hanson, Effect of Alkali-Silica Reaction Expansion and Cracking on Structural Behavior of Reinforced Concrete Beams, *ACI Struct. J.* 95 (5) (1998) 498–505.
- [38] L.J. Monette, N.J. Gardner, P.E. Grattan-Bellew, Residual Strength of Reinforced Concrete Beams Damaged by Alkali-Silica Reaction—Examination of Damage Rating Index Method, *ACI Mater. J.* 99 (1) (2002) 42–50.
- [39] C. Larive, Apports combinés de l'expérimentation et de la modélisation à la compréhension de l'alkali-réaction et de ses effets mécaniques, *Etudes et Recherches, OA 28, Laboratoire Central des Ponts et Chaussées, Paris, 1998.*